



## PIR MOTION SENSOR

Model: AU-XR8



Celling: 8m



IP20



Sensing area



Energy saving



3-2000 LUX

## INTRODUCTION

Welcome to use AU-XR8 infrared motion sensor!

The product adopts good sensitivity detector and integrated circuit. It gathers automatism, convenience, safety, saving-energy and practical functions. It utilizes the infrared energy from human as control-signal source and it can start the load at once when one enters detection field. It can identify day and night automatically. It is easy to install and used widely.

## TECHNICAL SPECIFICATIONS

|                               |   |
|-------------------------------|---|
| <b>Model</b>                  | : AU-XR8                                |
| <b>Power Source</b>           | : 220-240V/AC    50Hz                   |
| <b>Detection Range</b>        | : 360°                                  |
| <b>Detection Distance</b>     | : 8m max(<24°C)                         |
| <b>Ambient Light</b>          | : <3-2000LUX (Adjustable)               |
| <b>Rated Load</b>             | : 1200W (Incandescent), 600W (LED Load) |
| <b>Time Delay</b>             | : Min. 10Sec ±3Sec, Max. 30Min ±2Min    |
| <b>Installation Height</b>    | : Ceiling: (2.2-4m)                     |
| <b>Power Consumption</b>      | : Approx. 0.5W                          |
| <b>Working Temperature</b>    | : -20°C ~ +40°C                         |
| <b>Working Humidity</b>       | : <93%RH                                |
| <b>No. of Wires</b>           | : 3 Wires                               |
| <b>Detection Motion Speed</b> | : 0.6-1.5m/s                            |

## FUNCTIONAL MODES

### Can identify day and night

- You can adjust the working state in different ambient lights. It can work in the daytime and at night when adjusted to the “sun” position (max). It can work in less than 3 LUX ambient light when adjusted on the “moon” position (min). As for the adjustment pattern, please refer to the testing pattern.

### Time delay is added continually

- This sensor will restart to time when it receives the second induction signals within the first induction.

### Adjustable time delay

- The time delay can be set according to the customer’s desire. The minimum time is  $10\text{sec} \pm 3\text{sec}$ , and the maximum is  $30\text{min} \pm 2\text{min}$ .

## INSTALLATION INSTRUCTIONS

- As the detector responds to changes in temperature, avoid the following situations:
- Avoid pointing the detector towards objects with highly reflective surfaces, such as mirrors etc.
- Avoid mounting the detector near heat sources, such as heating vents, air conditioning units, light etc.

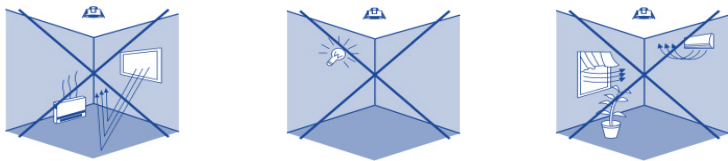

- Switch off the power & unload the transparent cover.
- Connect the power to connection terminal of sensor according to connection-wire diagram.
- Install back the transparent cover into the original location.
- Fold the metal spring of the sensor upwards and then put the sensor into the suitable hole or installation box. Releasing the spring, the sensor will be set in this installation position.
- After finishing installing, turn on the power and then test it.

## CONNECTION – WIRING DIAGRAM

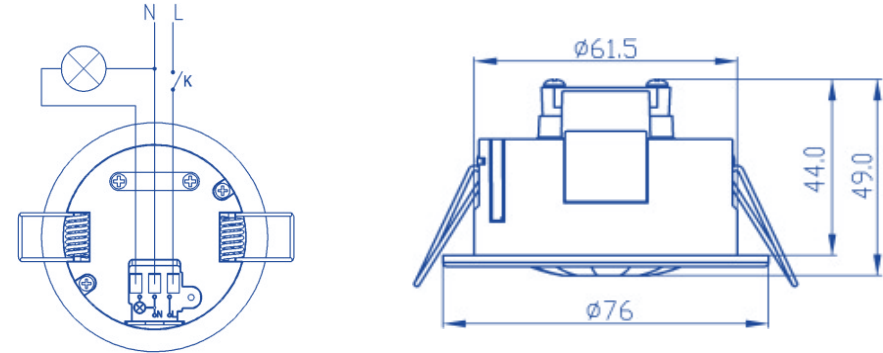

**Note:** When testing in daylight, please turn LUX knob to (SUN) position, otherwise the sensor could not work.

## TEST

- Turn the LUX knob clockwise on the maximum (sun). Turn the TIME knob anticlockwise on the minimum (10s).
- Switch on the power; the sensor and its connected lamp will have no signal at the beginning. After Warm-up 30sec, the sensor can start work. If the sensor receives the induction signal, the lamp will turn on. While there is no another induction signals any more, the load should stop working within  $10\text{sec} \pm 3\text{sec}$  and the lamp would turn off.
- Turn LUX knob anticlockwise on the minimum (3). If the ambient light is more than 3LUX, the sensor would not work, and the lamp stop working too. If the ambient light is less than 3LUX (darkness), the sensor would work. Under no induction signal condition, the sensor should stop working within  $10\text{sec} \pm 3\text{sec}$

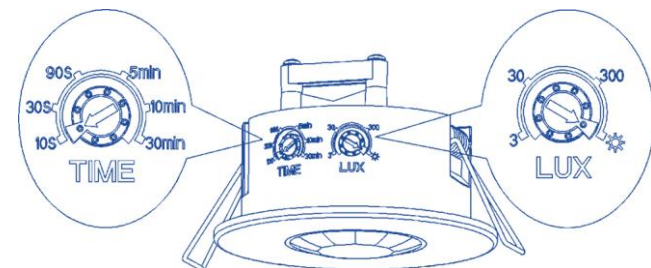

## LUX FUNCTION CHECK

### Daylight Function

The hold time is set to 30 seconds, and LUX is set to 300. The light switches on when it detects movement, and it switches off after 30 seconds of no movement.

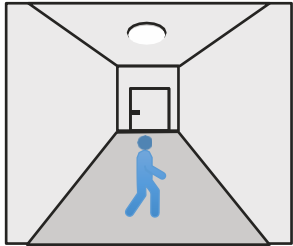

When the motion is detected with sufficient daylight (>300LUX), the light remains OFF.

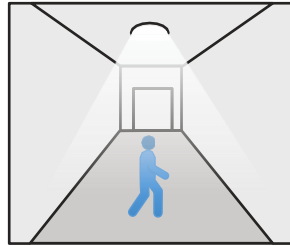

When the motion is detected with insufficient daylight (<300LUX), the light switches ON.

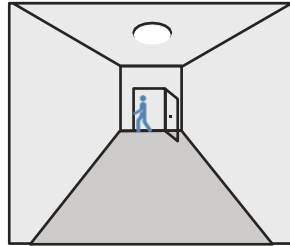

After the last detection and the present hold time-lapse (30 seconds), the light switches OFF.

### No Daylight Function

The hold time is set to 30 seconds, and LUX is set to ☀ or 2000. The light switches on when it detects movement, and when people leave, it switches off after the hold time is lapsed (30 seconds).

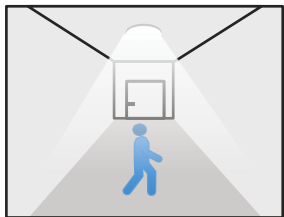

When the motion is detected, the sensor will switch on the light to 100% brightness

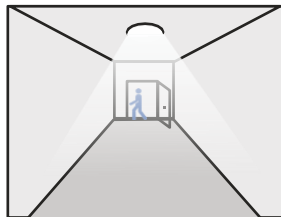

After the people leave the detection area, the light remains at 100% brightness within the hold time.

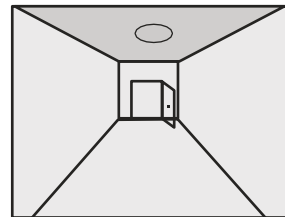

After the last detection and the present hold time-lapse (30 seconds), the light switches OFF.

## SAFETY INSTRUCTIONS

- An electrician or an experienced human can install it.
- It cannot be installed on an uneven and shaky surface.
- There shouldn't be any obstructive objects in front of the sensor that affect its detection.
- Avoid installing it near the metal and glass as they may affect the sensor.
- Please don't open the case if you find a hitch after the installation for your safety.

## DETECTION PATTEN

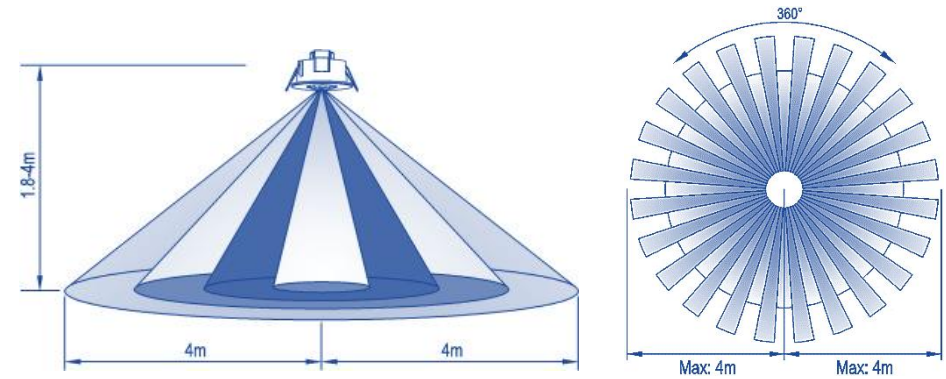

## APPLICATIONS



Washroom



Lobby



Parking



Dressing Area



Hotels

## TROUBLESHOOTING

| Malfunction                                 | Cause   | Remedy   |
|---|---|--|
| The load will not work                      | Wrong light control is selected<br>Faulty load<br>The main switch is switched OFF   | Adjust the setting change load<br>Turn the switch ON |
| The load is always on                       | There is a continuous movement in the detection zone  | Check the zone setting                               |
| The load will not work despite movement     | The sensor is not mounted for detecting the movement reliably<br>The movement has occurred, but the sensor does not identify it (for instance, the movement behind the wall, movement of a small object in immediate lamp vicinity, etc.) | Securely mount the enclosure<br>Check zone setting.  |
| The load will not work despite the movement | Rapid movements are being suppressed to minimize the malfunctioning or the detection<br>The zone that you have set is too small   | Check the zone setting                               |